



**TO**

SISTEMA PARETE HOSPITAL

Hospital line

SISTEMA PARETE HOSPITAL







**BASIH.600 + PIEDE H.150**

DESCRIZIONE DESCRIPTION	CODICE CODE	DIMENSIONI (mm) SIZE (mm)					
		L	P	H			
Riempitivi Terminali per Basi	WALLB000	230	<b>20</b>	600			
Base a Giorno - 1 ripiano	WALLB006	460	<b>440</b>	600			
	WALLB090	460	<b>640</b>	600			
Base 1 Anta - 1 ripiano	WALLB009	460	<b>460</b>	600			
	WALLB093	460	<b>660</b>	600			
Base 3 Cassetti	WALLB018	460	<b>460</b>	600			
	WALLB108	460	<b>660</b>	600			

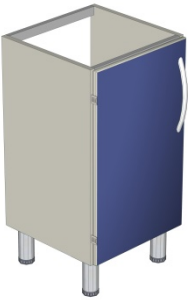
BASI H.740 + PIEDE H.150

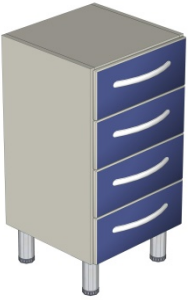
DESCRIZIONE DESCRIPTION	CODICE CODE	DIMENSIONI (mm) SIZE (mm)					
		L	P	H			
Riempitivi Terminali per Basi	WALLB001	230	<b>20</b>	740			
Base a Giorno - 1 ripiano	WALLB174	460	<b>440</b>	740			
	WALLB249	460	<b>640</b>	740			
Base 1 Anta - 1 ripiano	WALLB177	460	<b>460</b>	740			
	WALLB252	460	<b>660</b>	740			
Base 1 Anta Vetro - 1 ripiano	WALLB180	460	<b>460</b>	740			
	WALLB255	460	<b>660</b>	740			

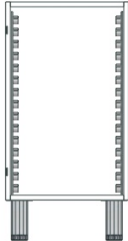
BASI H.740 + PIEDE H.150

DESCRIZIONE DESCRIPTION	CODICE CODE	DIMENSIONI (mm) SIZE (mm)					
		L	P	H			
		Base 1 Anta Sottolavello con fondo in alluminio	WALLB183	460			
	WALLB258	460	<b>660</b>	740			
							
Base 4 Cassetti	WALLB186	460	<b>460</b>	740			
	WALLB267	460	<b>660</b>	740			
							
Base 1 Anta per cesti	WALLB261	460	<b>660</b>	740			
							
							
Base 1 Anta Vetro per cesti	WALLB264	460	<b>660</b>	740			
							
							

BASI H.740 + PIEDE H.150

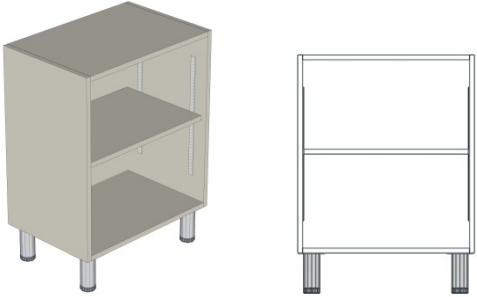
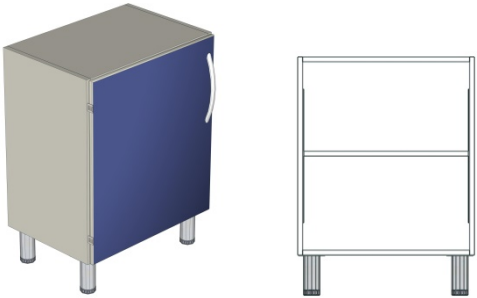
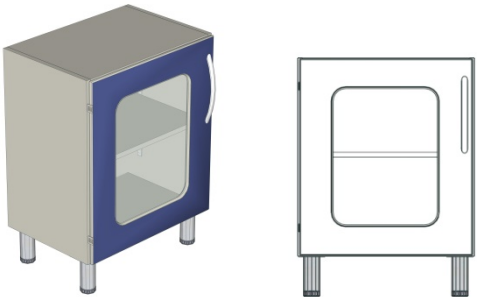
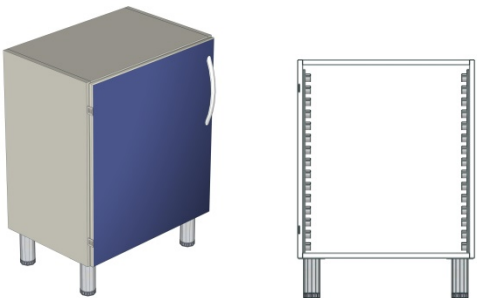
DESCRIZIONE DESCRIPTION	CODICE CODE	DIMENSIONI (mm) SIZE (mm)					
		L	P	H			
Base a Giorno - 1 ripiano  	WALLB195	660	<b>440</b>	740			
	WALLB285	660	<b>640</b>	740			
Base 1 Anta - 1 ripiano  	WALLB198	660	<b>460</b>	740			
	WALLB288	660	<b>660</b>	740			
Base 1 Anta Vetro - 1 ripiano  	WALLB201	660	<b>460</b>	740			
	WALLB291	660	<b>660</b>	740			
Base 1 Anta per cesti  	WALLB204	660	<b>460</b>	740			

BASI H.740+ PIEDE H.150

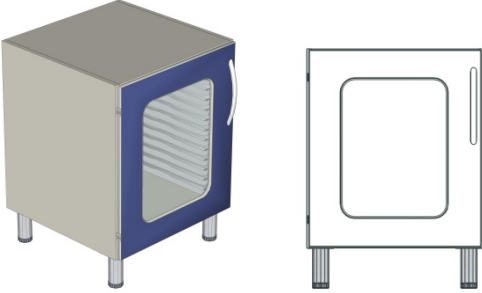
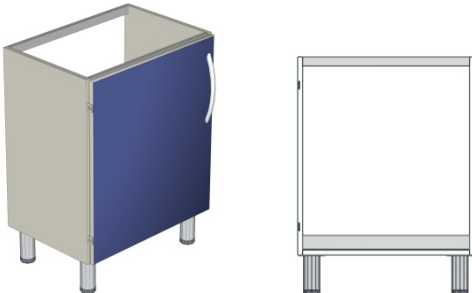
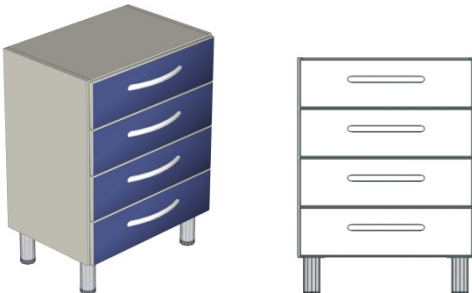
DESCRIZIONE DESCRIPTION	CODICE CODE	DIMENSIONI (mm) SIZE (mm)					
		L	P	H			
Base 1 Anta Vetro per Cesti  	WALLB207	660	<b>460</b>	740			
Base 1 Anta Sottolavello con fondo in alluminio  	WALLB208 WALLB294	660 660	<b>460</b> <b>660</b>	740 740			
Base 4 Cassetti  	WALLB209 WALLB297	660 660	<b>460</b> <b>660</b>	740 740			

BASI H.740 H.150 PIEDE

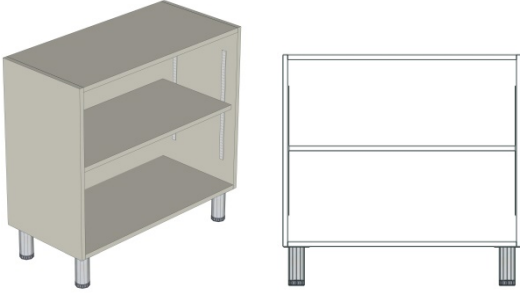
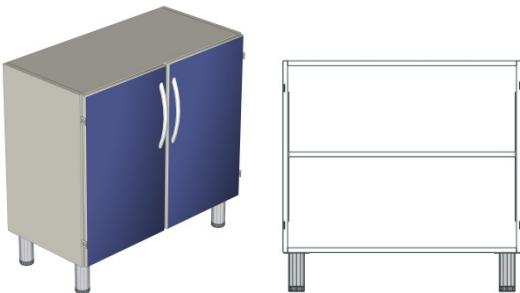
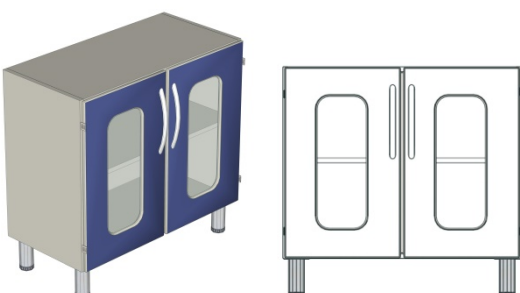
DESCRIZIONE DESCRIPTION	CODICE CODE	DIMENSIONI (mm) SIZE (mm)					
		L	P	H			
Base a Giorno – 1 Ripiano  	WALLB216	920	<b>440</b>	740			
	WALLB306	920	<b>640</b>	740			
Base 2 Ante – 1 Ripiano  	WALLB219	920	<b>460</b>	740			
	WALLB309	920	<b>660</b>	740			
Base 2 Ante Vetro – 1 Ripiano  	WALLB222	920	<b>460</b>	740			
	WALLB312	920	<b>660</b>	740			



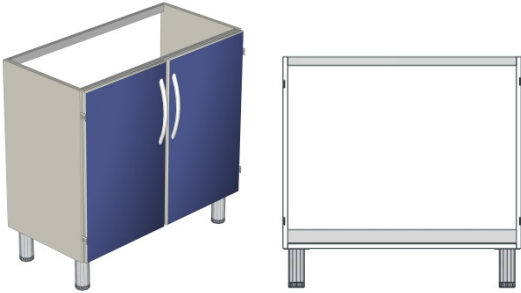
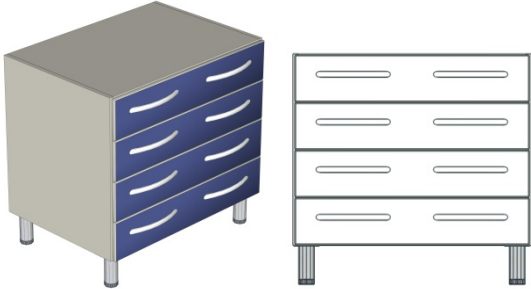

BASI H.740 + PIEDE H.150

DESCRIZIONE DESCRIPTION	CODICE CODE	DIMENSIONI (mm) SIZE (mm)				
		L	P	H		
Base 2 Ante Sottolavello con fondo in alluminio  	WALLB225	920	<b>460</b>	740		
	WALLB315	920	<b>660</b>	740		
Base 4 Cassetti  	WALLB226	920	<b>460</b>	740		
	WALLB316	920	<b>660</b>	740		

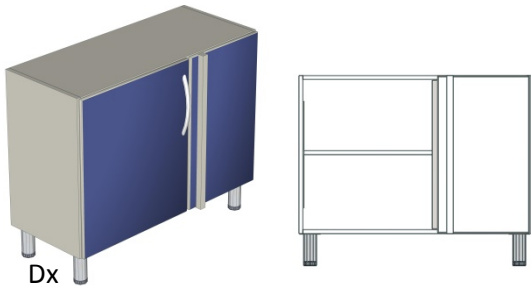
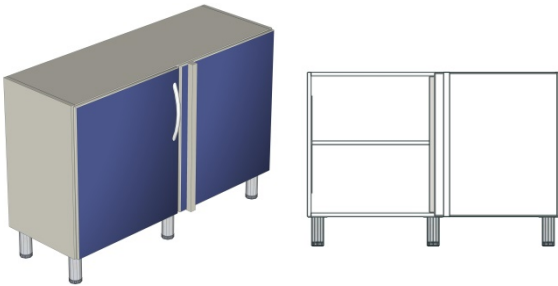
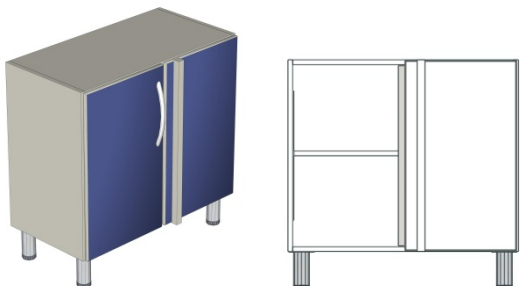
**BASI H.740 + PIEDE H.150**

DESCRIZIONE DESCRIPTION	CODICE CODE	DIMENSIONI (mm) SIZE (mm)					
		L	P	H			
Base 2 Anta angolare – 1 ripiano angolare maniglia su anta L.654   Dx	WALLB239	1150	<b>460</b>	740			
	WALLB336	1150	<b>660</b>	740			
Base 2 Ante angolare – 1 ripiano angolare  	WALLB241	1350	<b>460</b>	740			
	WALLB339	1350	<b>660</b>	740			
Base 2 Ante Angolare – 1 ripiano angolare  	WALLB243	1350	<b>460</b>	740			
	WALLB335	1350	<b>660</b>	740			

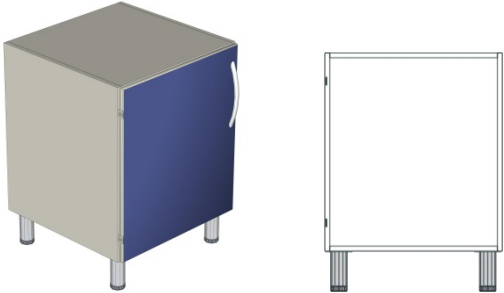



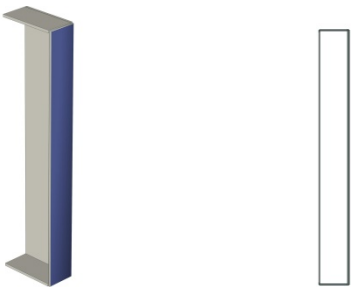
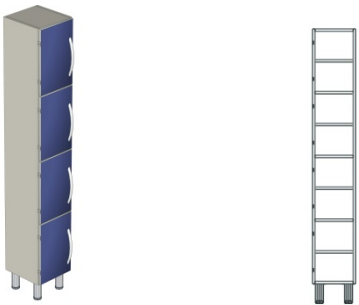
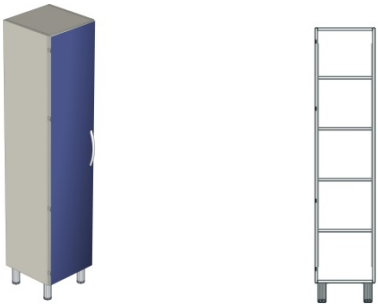
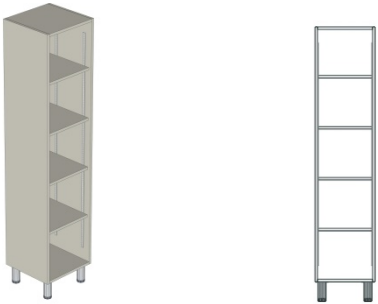

BASI H.740 + PIEDE H.150

DESCRIZIONE DESCRIPTION	CODICE CODE	DIMENSIONI (mm) SIZE (mm)					
		L	P	H			
Base 1 Anta - Per Frigo Incasso  	WALLB283	660	<b>660</b>	740			
Base Predisposta per Frigo Farmaci 140 Lt.  	WALLB286	660	<b>660</b>	740			
Base 2 Cassettoni Porta Cartelle  	WALLB300	660	<b>660</b>	740			

COLONNE H.1960 + PIEDE H.150

DESCRIZIONE DESCRIPTION	CODICE CODE	DIMENSIONI (mm) SIZE (mm)					
		L	P	H			
Riempitivo Terminale per Colonne  	WALLC000	230	<b>18</b>	1960			
Colonna 4 Ante – Con Serratura  	WALLC468	330	<b>350</b>	1960			
Colonna 1 Anta – 4 Ripiani  	WALLC519 WALLC588	460	<b>460</b> <b>660</b>	1960			
Colonna a Giorno – 4 Ripiani  	WALLC516 WALLC585	460	<b>440</b> <b>640</b>	1960			

COLONNE H.1960 + PIEDE H.150

DESCRIZIONE DESCRIPTION	CODICE CODE	DIMENSIONI (mm) SIZE (mm)					
		L	P	H			
Colonna 1 Anta Vetro – 4 Ripiani   	WALLC522	460	<b>460</b>	1960			
	WALLC591	460	<b>660</b>	1960			
Colonna Spogliatoio 1 Anta – 1 Ripiani, Appendini <b>Utenza Singola</b> <b>Con Serratura</b>   	WALLC525 vano unico	460	<b>460</b>	1960			
	WALLC600 vano unico	460	<b>660</b>	1960			
Colonna Spogliatoio 1 Anta – 1 Ripiani, Appendini <b>Utenza Singola</b> <b>Con Serratura</b>   	WALLC526 Vano sporco-pulito	460	<b>460</b>	1960			

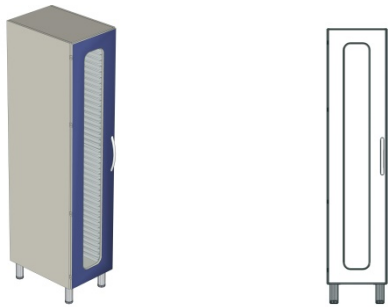

COLONNE H.1960 + PIEDE H.150

DESCRIZIONE DESCRIPTION	CODICE CODE	DIMENSIONI (mm) SIZE (mm)					
		L	P	H			
<p>Colonna 1 Anta – Cesti</p> 	WALLC594	460	<b>660</b>	1960			
<p>Colonna 1 Anta Vetro - Cesti</p> 	WALLC597	460	<b>660</b>	1960			

COLONNE H.1960 + PIEDE H.150



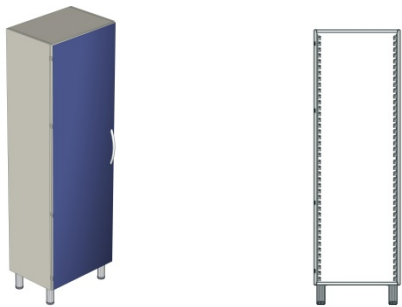
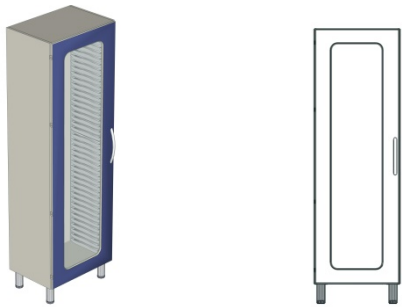





DESCRIZIONE DESCRIPTION	CODICE CODE	DIMENSIONI (mm) SIZE (mm)					
		L	P	H			
Colonna 1 Anta – 4 Ripiani   	WALLC534  WALLC609	660  660	<b>460</b> <b>660</b>	1960  1960			
Colonna a Giorno – 4 Ripiani   	WALLC531  WALLC606	660  660	<b>440</b> <b>640</b>	1960  1960			
Colonna 1 Anta Vetro – 4 Ripiani   	WALLC537  WALLC612	660  660	<b>460</b> <b>660</b>	1960  1960			
Colonna 2 Ante – 2 Ripiani,4 Appendini Con Serratura   	WALLC546  WALLC615	660  660	<b>460</b> <b>660</b>	1960  1960			

COLONNE H.1960 + PIEDE H.150



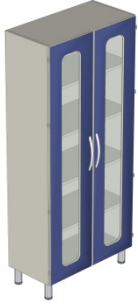



DESCRIZIONE DESCRIPTION	CODICE CODE	DIMENSIONI (mm) SIZE (mm)					
		L	P	H			
<p>Colonna 1 Anta – Cesti</p> 	WALLC540	660	<b>460</b>	1960			
<p>Colonna 1 Anta Vetro – Cesti</p> 	WALLC543	660	<b>460</b>	1960			
<p>Colonna 8 Antine <b>Con Serratura</b></p> 	WALLC549	660	<b>460</b>	1960			
<p>Colonna Predisposta per Frigo Farmaci lt.200</p> 	WALLC605	660	<b>660</b>	2100			



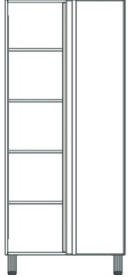

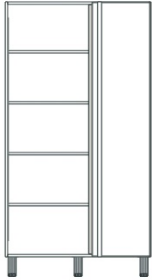

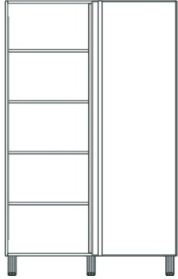

COLONNE H.1960 + PIEDE H.150

DESCRIZIONE DESCRIPTION	CODICE CODE	DIMENSIONI (mm) SIZE (mm)					
		L	P	H			
Colonna 2 Ante – 4 Ripiani   	WALLC558  WALLC624	920  920	<b>460</b> <b>660</b>	1960  1960			
Colonna a Giorno – 4 Ripiani   	WALLC555  WALLC621	920  920	<b>440</b> <b>640</b>	1960  1960			
Colonna 2 Ante Vetro – 4 Ripiani   	WALLC561  WALLC627	920  920	<b>460</b> <b>660</b>	1960  1960			
Colonna 2 Ante Spogliatoio - Tubo Appendiabiti <b>Utenza Doppia</b> <b>Con Serratura</b>   	WALLC565	920	<b>460</b>	1960			

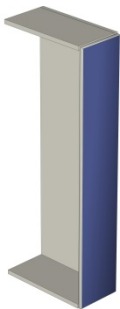
COLONNE H.1960 + PIEDE H.150

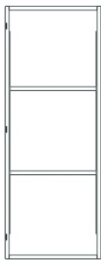
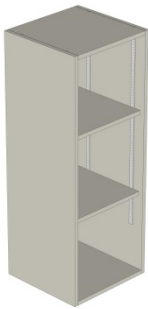
DESCRIZIONE DESCRIPTION	CODICE CODE	DIMENSIONI (mm) SIZE (mm)					
		L	P	H			
Colonna 1 Anta – 4 Ripiani, <b>Angolare</b>	WALLC579	950	<b>460</b>	1960			
	WALLC649	950	<b>660</b>	1960			
							
Colonna 1 Anta – 4 Ripiani, <b>Angolare</b>	WALLC576	1150	<b>460</b>	1960			
	WALLC650	1150	<b>660</b>	1960			
<b>Dx</b> 							
Colonna 1 Anta – 4 Ripiani, <b>Angolare</b>	WALLC578	1350	<b>460</b>	1960			
	WALLC651	1350	<b>660</b>	1960			
							
Col. <b>Medicinali</b> 2 Ante – Ripiani, Contenitori , Porta Stupefacenti - <b>Con Serratura</b>	WALLC636	920	<b>660</b>	1960			
							



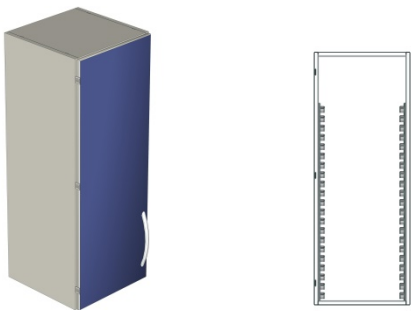
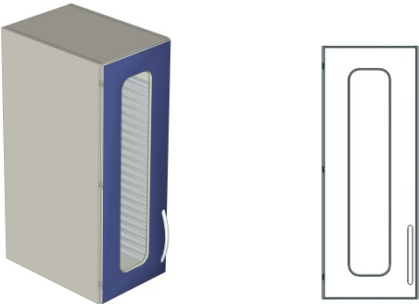

## SOPRABASE H.1220

DESCRIZIONE DESCRIPTION	CODICE CODE	DIMENSIONI (mm) SIZE (mm)					
		L	P	H			
Riempitivo Terminale per Soprabasi	WALLE000	230	<b>18</b>	1220			
 							
Soprabase 1 Anta – 2 Ripiani	WALLE348	460	<b>460</b>	1220			
	WALLE405	460	<b>660</b>	1220			
 							
Soprabase a Giorno – 2 Ripiani	WALLE345	460	<b>440</b>	1220			
	WALLE402	460	<b>640</b>	1220			
 							
Soprabase 1 Anta Vetro – 2 Ripiani	WALLE351	460	<b>460</b>	1220			
	WALLE408	460	<b>660</b>	1220			
 							



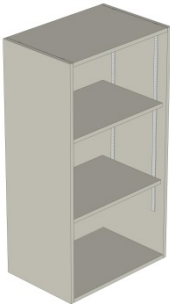

## SOPRABASE H.1220

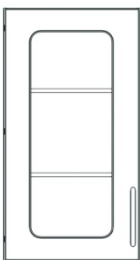
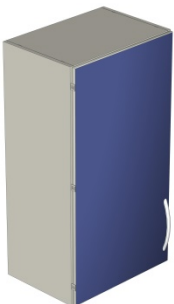
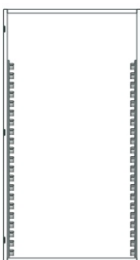
DESCRIZIONE DESCRIPTION	CODICE CODE	DIMENSIONI (mm) SIZE (mm)					
		L	P	H			
Soprabase 1 Anta – Cesti  	WALLE411	460	<b>660</b>	1220			
Soprabase 1 Anta Vetro – Cesti  	WALLE414	460	<b>660</b>	1220			

## SOPRABASE H.1220

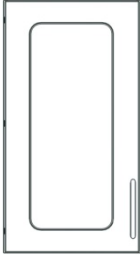
DESCRIZIONE DESCRIPTION	CODICE CODE	DIMENSIONI (mm) SIZE (mm)					
		L	P	H			
Soprabase 1 Anta – 2 Ripiani   	WALLE348	660	<b>460</b>	1220			
	WALLE405	660	<b>660</b>	1220			
Soprabase a Giorno – 2 Ripiani   	WALLE357	660	<b>440</b>	1220			
	WALLE423	660	<b>640</b>	1220			
Soprabase 1 Anta Vetro – 2 Ripiani   	WALLE363	660	<b>460</b>	1220			
	WALLE429	660	<b>660</b>	1220			
Soprabase 1 Anta – Cesti   	WALLE366	660	<b>460</b>	1220			

## SOPRABASE H.1220

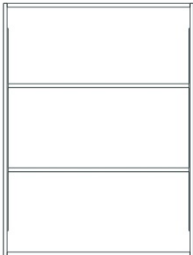
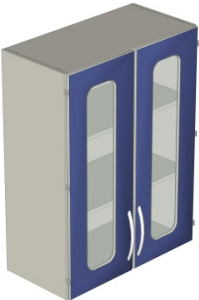
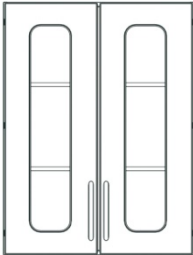
DESCRIZIONE DESCRIPTION	CODICE CODE	DIMENSIONI (mm) SIZE (mm)					
		L	P	H			
Soprabase 1 Anta Vetro – Cesti	WALLE369	660	<b>460</b>	1220			
 							
Soprabase Coppia Ante – 2 Ripiani	WALLE378	920	<b>460</b>	1220			
	WALLE436	920	<b>660</b>	1220			
 							
Soprabase a Giorno – 2 Ripiani	WALLE375	920	<b>440</b>	1220			
	WALLE438	920	<b>640</b>	1220			
 							
Soprabase Coppia Ante Vetro – 2 Ripiani	WALLE381	920	<b>460</b>	1220			
	WALLE444	920	<b>660</b>	1220			
 							

## SOPRABASE H.1220

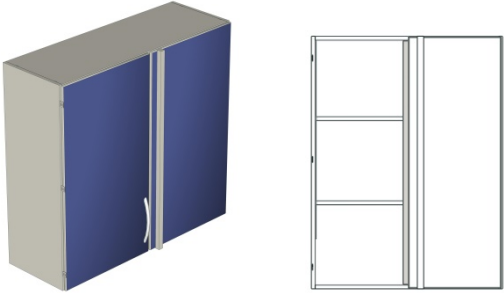
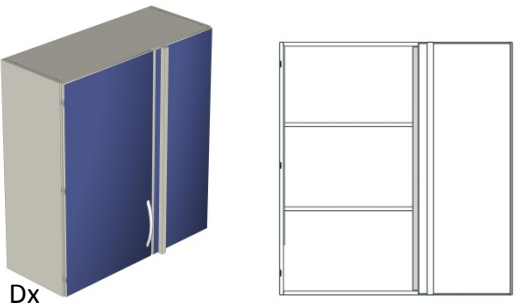
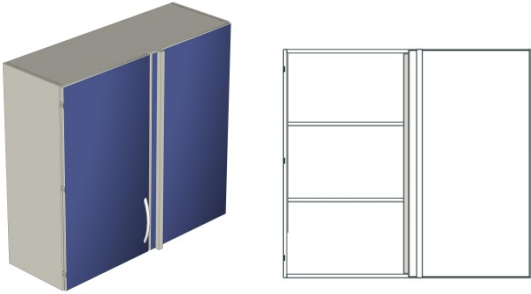
DESCRIZIONE DESCRIPTION	CODICE CODE	DIMENSIONI (mm) SIZE (mm)					
		L	P	H			
Soprabase 1 Anta – 2 Ripiani , Angolare  	WALLE396	950	<b>460</b>	1220			
	WALLE457	950	<b>660</b>	1220			
Soprabase 1 Anta – 2 Ripiani , Angolare  	WALLE393	1150	<b>460</b>	1220			
	WALLE456	1150	<b>660</b>	1220			
Soprabase 1 Anta – 2 Ripiani , <b>Angolare</b>  	WALLE395	1350	<b>460</b>	1220			
	WALLE459	1350	<b>660</b>	1220			

**PENSILIH.600**

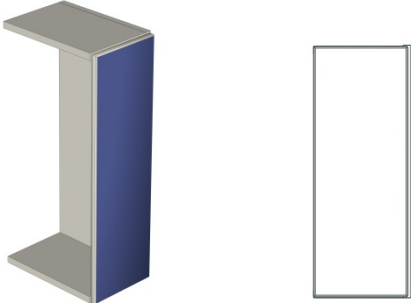
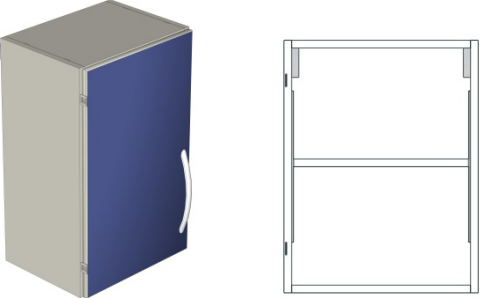
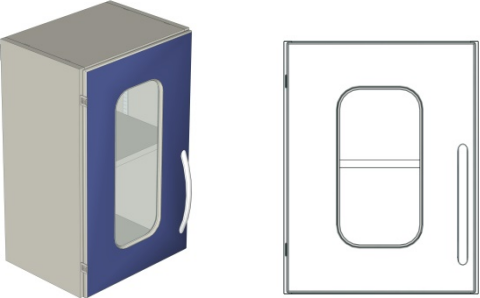
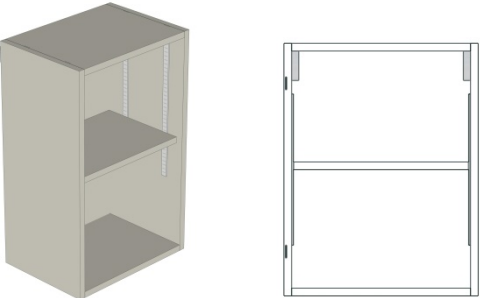
DESCRIZIONE DESCRIPTION	CODICE CODE	DIMENSIONI (mm) SIZE (mm)					
		L	P	H			
Riempitivi terminali per Pensili	WAALP000	230	<b>18</b>	600			
							
Pensile 1 Anta con 1 Ripiano	WALLP660	460	<b>350</b>	600			
							
Pensile 1 Anta Vetro con 1 Ripiano	WALLP663	460	<b>350</b>	600			
							
Pensile a Giorno con 1 Ripiano	WALLP657	460	<b>330</b>	600			
							





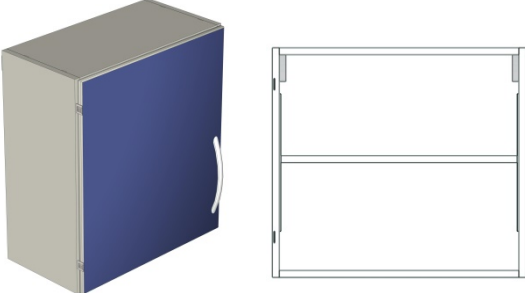
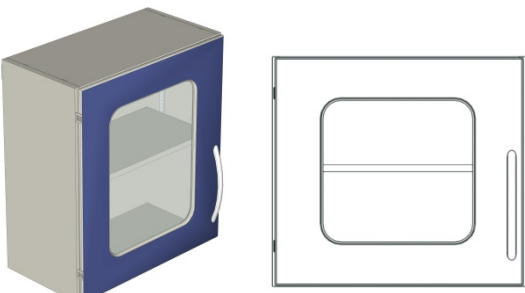
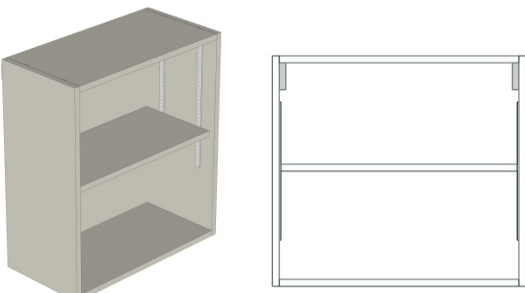
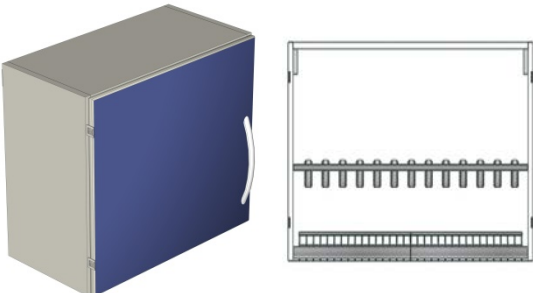

PENSILI H.600 / L.660

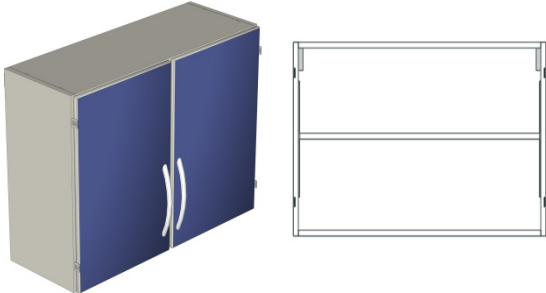
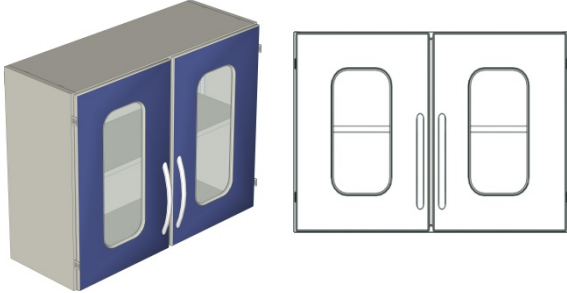
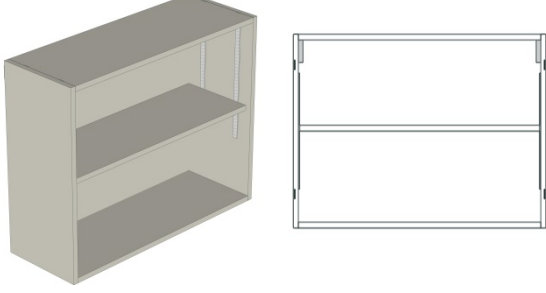
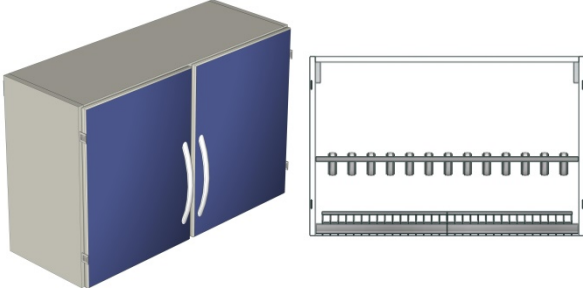
DESCRIZIONE DESCRIPTION	CODICE CODE	DIMENSIONI (mm) SIZE (mm)					
		L	P	H			
Pensile 1 Anta con 1 Ripiano 	WALLP675	660	<b>350</b>	600			
Pensile 1 Anta Vetro con 1 Ripiano 	WALLP678	660	<b>350</b>	600			
Pensile a Giorno con 1 Ripiano 	WALLP672	660	<b>330</b>	600			
Pensile 1 Anta - Scolapiatti 	WALLP679	660	<b>350</b>	600			

**PENSILI H.600 / L.920**

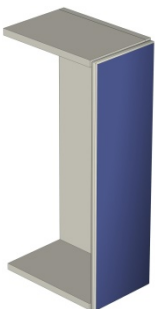
DESCRIZIONE DESCRIPTION	CODICE CODE	DIMENSIONI (mm) SIZE (mm)					
		L	P	H			
Pensile 2 Ante con 1 Ripiano 	WALLP690	920	<b>350</b>	600			
Pensile 2 Ante Vetro con 1 Ripiano 	WALLP693	920	<b>350</b>	600			
Pensile a Giorno con 1 Ripiano 	WALLP687	920	<b>330</b>	600			
Pensile 2 Ante - <b>Scolapiatti</b> 	WALLP696	920	<b>350</b>	600			

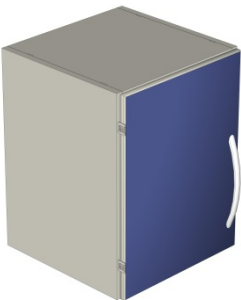
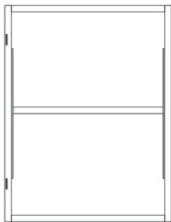
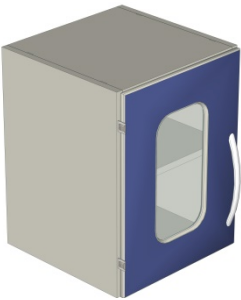
## SOPRALZI H.600

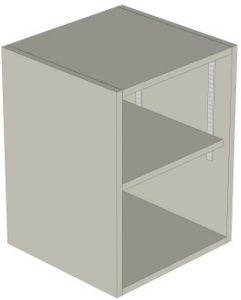
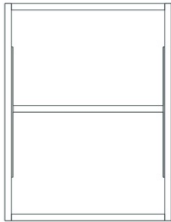
DESCRIZIONE DESCRIPTION	CODICE CODE	DIMENSIONI (mm) SIZE (mm)					
		L	P	H			
Riempitivi terminali per Sopralzi	WAALP000	230	<b>18</b>	600			
 							
Sopralzo 1 Anta – 1 Ripiano	WALLS777	460	<b>460</b>	600			
 	WALLS840	460	<b>660</b>	600			
	WALLS789	660	<b>460</b>	600			
	WALLS858	660	<b>660</b>	600			
Sopralzo 1 Anta Vetro – 1 Ripiani	WALLS780	460	<b>460</b>	600			
 	WALLS843	460	<b>660</b>	600			
	WALLS792	660	<b>460</b>	600			
	WALLS861	660	<b>660</b>	600			
Sopralzo a Giorno – 1 Ripiani	WALLS774	460	<b>440</b>	600			
 	WALLS837	460	<b>640</b>	600			
	WALLS786	660	<b>440</b>	600			
	WALLS855	660	<b>640</b>	600			

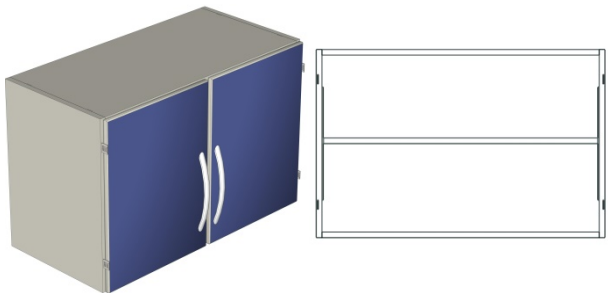
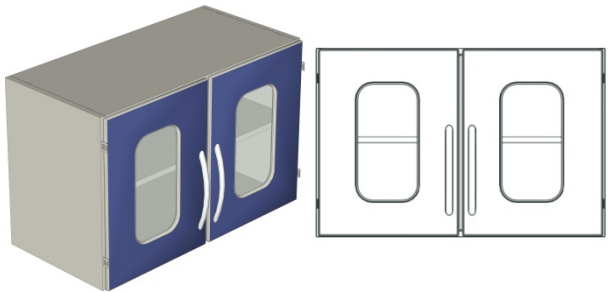
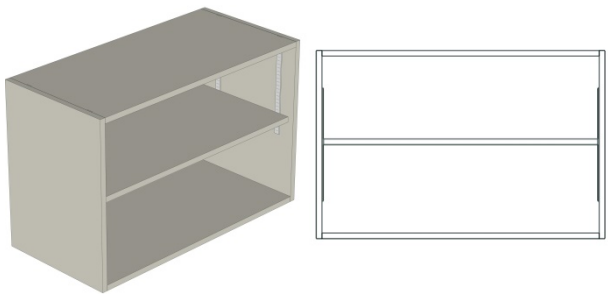

## SOPRALZI H.600

DESCRIZIONE DESCRIPTION	CODICE CODE	DIMENSIONI (mm) SIZE (mm)					
		L	P	H			
Sopralzo 2 Ante – 1 Ripiano  	WALLS807	920	<b>460</b>	600			
	WALLS870	920	<b>660</b>	600			
Sopralzo 2 Ante Vetro – 1 Ripiano  	WALLS810	920	<b>460</b>	600			
	WALLS873	920	<b>660</b>	600			
Sopralzo a Giorno – 1 Ripiano  	WALLS804	920	<b>440</b>	600			
	WALLS867	920	<b>640</b>	600			

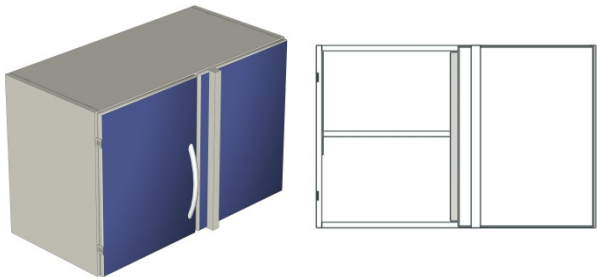
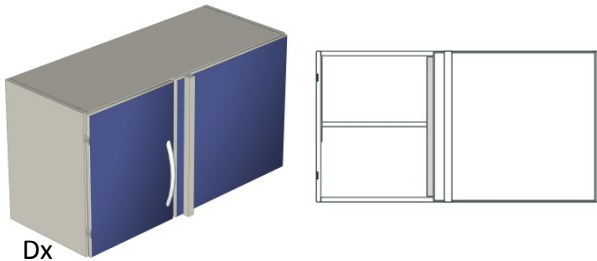
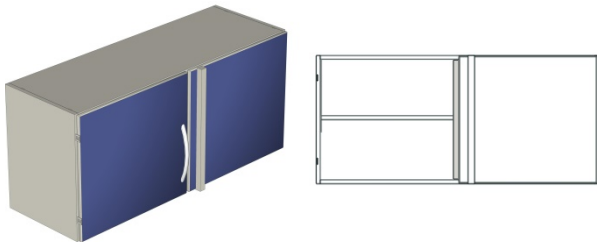
## SOPRALZI ANGOLARE H.600

DESCRIZIONE DESCRIPTION	CODICE CODE	DIMENSIONI (mm) SIZE (mm)					
		L	P	H			
Sopralzo 1 Anta – 1 Ripiano, <b>Angolare</b>	WALLS828	950	<b>460</b>	600			
	WALLS886	950	<b>660</b>	600			
							
Sopralzo 1 Anta – 1 Ripiano, <b>Angolare</b>	WALLS829	1150	<b>460</b>	600			
	WALLS885	1150	<b>660</b>	600			
 <p>Dx</p>							
Sopralzo 1 Anta – 1 Ripiano, <b>Angolare</b>	WALLS830	1350	<b>460</b>	600			
	WALLS888	1350	<b>660</b>	600			
							

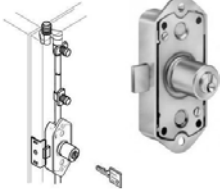
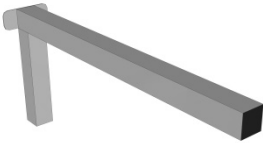
ACCESSORI

DESCRIZIONE DESCRIPTION	CODICE CODE	DIMENSIONI (mm) SIZE (mm)					
		L	P	H			
Serratura per anta    	WARH0014 a catenaccio						
	WARH0015 Ad asta rotante						
Staffa Reggipiano  	WAAAPA00 pf.400	15	<b>400</b>	280			
	WAAAPA03 pf.600	15	<b>600</b>	280			
Piano Fasciatoio Imbottito <b>Rivestimento Ecopelle Ignifuga</b> <b>Arancio – Verde - Blu</b>  	WAAFA40	660	<b>750</b>	80			
	WAAFA50	920	<b>750</b>	80			

BASAMENTI

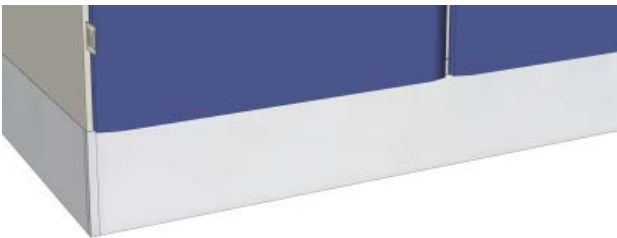
DESCRIZIONE DESCRIPTION	CODICE CODE	DIMENSIONI (mm) SIZE (mm)					
		L	P	H			
Set 4 Ruote per Basi Singole Diam. 80  	WAABE070	80		88			
Basamento Zoccolo Estraibile in alluminio h.120 <b>In alternativa ai 4 piedi in metallo h. 150</b>  	WAABZ000	1000		120			

TOP SUPERIORI

DESCRIZIONE DESCRIPTION	CODICE CODE	DIMENSIONI (mm) SIZE (mm)					
		L	P	H			
Piano Top Postformato Bordo Dritto <b>finitura grigio T.01</b>	WAAAPB27	1000	<b>470</b>	30			
	WAAAPB28	1000	<b>670</b>	30			
							
Alzatina per piano Top Postformato al ML <b>finitura alluminio</b>	WAAAZ00	1000	10	25			
							
Piano Ton in Corian – Senza Alzatina	WAAAPO03	1000	470	30			
	WAAAPO06	1000	670	30			
							
Alzatina in Corian – <u>Incollata sul piano</u> al ML Raccordata con piano - <b>finitura Glacier White T.02</b>	WAAAPV48	1000	12	50			
Alzatina in Corian <u>da Incollare</u> al ML <b>finitura Glacier White T.02</b>	WAAAPV49	1000	12	50			
Bordo antigoccia per piano in Corian al ML	WAAAPV51	1000	5				

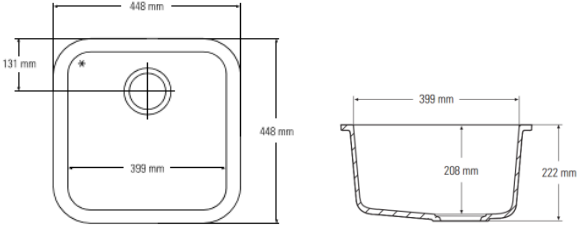
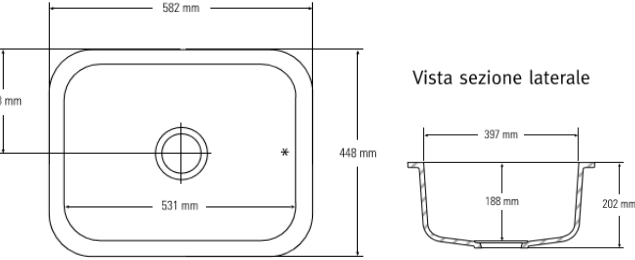
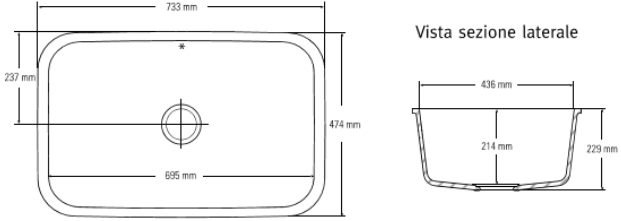

## VASCHE IN CORIAN

DESCRIZIONE DESCRIPTION	CODICE CODE	DIMENSIONI (mm) SIZE (mm)					
		L	P	H			
<p>Vasca in Corian art. 804 <b>finitura Glacier White T.02</b></p> 	WAAAPV42	448	<b>448</b>	222			
<p>Vasca in Corian art. 871 <b>finitura Glacier White T.02</b></p> 	WAAPV45	582	<b>448</b>	202			
<p>Vasca in Corian Pediatria Infanzia art. 881 <b>finitura Glacier White T.02</b></p> 	WAAPV49	733	<b>474</b>	229			

## VASCHE INOX

DESCRIZIONE DESCRIPTION	CODICE CODE	DIMENSIONI (mm) SIZE (mm)					
		L	P	H			
Lavello ad Incasso in Acciaio Inox <b>Pozzetto</b>  	LT431 pozzetto	435	<b>435</b>	185			
Lavello ad Incasso in Acciaio Inox <b>1 Vasca</b>  	LR431 1 vasca	435	<b>500</b>	180			
Lavello ad Incasso in Acciaio Inox <b>1 Vasca + Gocciolatoio</b>  	LV807 D 1 vasca + gocc. DESTRO  LV807 S 1 vasca + gocc. SINISTRO	790	<b>500</b>	180			
Lavello ad Incasso in Acciaio Inox <b>2 Vasche</b>  	LV808	790	<b>500</b>	180			

VASCHE INOX E RUBINETTERIE

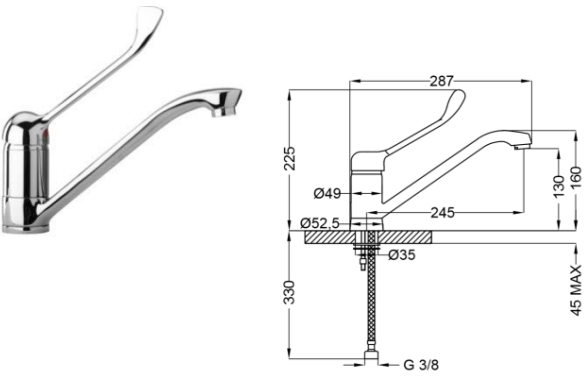
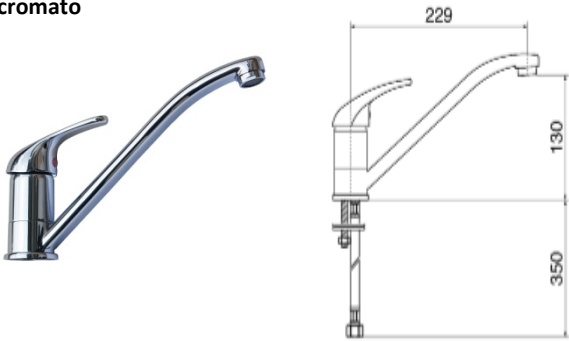
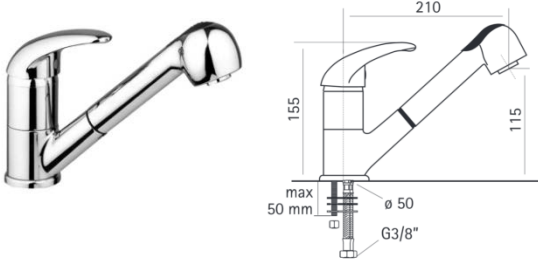
DESCRIZIONE DESCRIPTION	CODICE CODE	DIMENSIONI (mm) SIZE (mm)					
		L	P	H			
<p>Lavello ad Incasso in Acciaio Inox <b>2 Vasche + SCIVOLO</b></p> 	<p>LVC05 D 2 vasche + gocc. DESTRO</p> <p>LVC05 S 2 vasche + gocc. SINISTRO</p>	1160	<b>500</b>	180			
<p>Miscelatore con leva clinica <b>cromato</b></p> 	92543		<b>287</b>	225			
<p>Miscelatore <b>cromato</b></p> 	MX000		<b>279</b>	135			
<p>Miscelatore con leva clinica e doccetta estraibile <b>cromato</b></p> 	MX32M		<b>260</b>	205			

## PIANI COTTURA

DESCRIZIONE DESCRIPTION	CODICE CODE	DIMENSIONI (mm) SIZE (mm)					
		L	P	H			
Piano cottura a 2 piastre elettriche termo protette Potenza assorbita 3,5 Kw 	PC305	300	<b>500</b>	13,5			
Piano cottura a 4 piastre elettriche termo protette Potenza assorbita 7 Kw 	PC606	580	<b>500</b>	6			
Piano cottura elettrico vetroceramica da 30 Potenza assorbita 3 Kw 	PV301	285	<b>505</b>	4			
Piano cottura elettrico vetroceramica da 60 Potenza assorbita 6 Kw 	PV601	575	<b>505</b>	4			

FRIGORIFERI - LAVASTOVGLIE

DESCRIZIONE DESCRIPTION	CODICE CODE	DIMENSIONI (mm) SIZE (mm)					
		L	P	H			
Frigorifero combinato da incasso sottotop - classe A+ Capacità totale lt. 102 (83 frigo – 19 freezer)	EF60E DX	580	<b>545</b>	815			
	EF60E SX	580	<b>545</b>	815			
							
Frigorifero porta medicinali monotemperatura MOD.MEDIKA 140 ECT-F Capacità 140 LT.	140ECT-F	520	<b>635</b>	835			
							
Frigorifero porta medicinali monotemperatura MOD.MEDIKA 200 ECT-F Capacità 200 LT.	200ECT-F	600	<b>655</b>	1460			
							

ACCESSORI

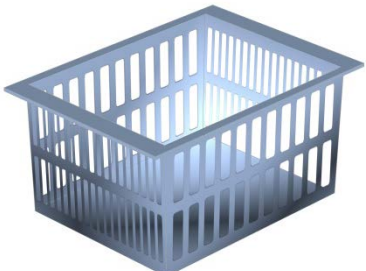
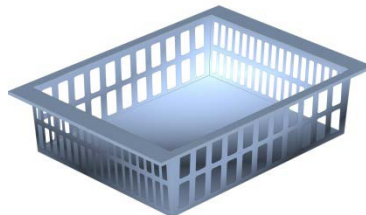
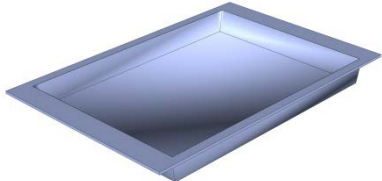
DESCRIZIONE DESCRIPTION	CODICE CODE	DIMENSIONI (mm) SIZE (mm)					
		L	P	H			
Cesto alto	WA46000	600	<b>400</b>	200			
Divisorio lato lungo	WA46027	600		200			
Divisorio lato corto	WA46028	400		200			
							
Cesto medio	WA46005	600	<b>400</b>	100			
Divisorio lato lungo	WA46029	600		100			
Divisorio lato corto	WA46030	400		100			
							
Cesto basso	WA46011	600	<b>400</b>	50			
Divisorio lato lungo	WA46034	600		50			
Divisorio lato corto	WA46035	400		50			
							

**COLORI FRONTALI**



**M 700 GRIGIO**



**M 300 ARANCIO**



**M 602 BLU**

**COLORI STRUTTURA**

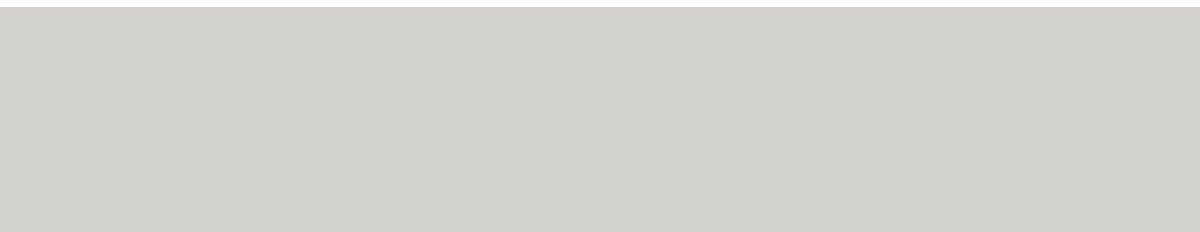

**M 700 GRIGIO**

**CONTATTI**  
**CONTACTS**

Via Guizza Alta, 1 - 30037  
Scorzè - Venezia - Italy  
tel. +39 3935727111  
[danielecodato@hotmail.com](mailto:danielecodato@hotmail.com)



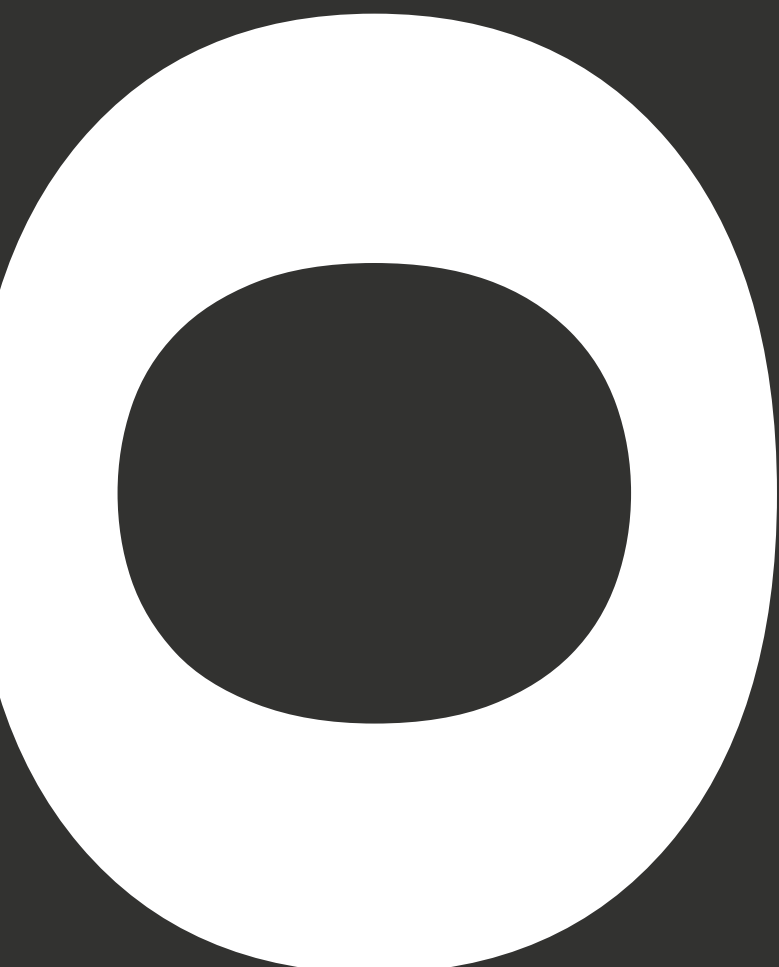

La ditta si riserva di apportare  
quelle modifiche tecniche ed  
estetiche che ritiene più opportune,  
per migliorare il prodotto,  
anche senza preavviso.

The company reserves the right  
to make technical and  
aesthetic modifications  
as it sees fit,  
in order to improve  
the product, without warning.





**DANIELECODATO**  
italianhospitalfurniture

Via Guizza Alta, 1 - 30037 Scorzè - Venezia - Italy  
tel. +39 0438 975666 fax +39 0438 975656  
danielecodato@hotmail.com